

TK 1811 – Polystyrene and Polycarbonate – 180x110mm (7.09x4.33in.)

Standard Features

- **Protection Level:** IP66 (NEMA Type: 4X with gray cover, 12K with transparent cover)
- **Technical:** Smooth or Knockout Sidewalls
Gray or Tinted Transparent Cover
Multiple Enclosure Mounting Options
- **Enclosure Material:** Polystyrene or Polycarbonate
- **Gasket Material:** Polyurethane
- **Color:** Light Gray
- **Temperature Range:** Polystyrene
-40°C to 70°C (-40°F to 158°F)
Polycarbonate
-35°C to 120°C (-31°F to 248°F)
- **Accessories:** See section below



Smooth Sidewalls

Ordering Information		Height mm (in)	Polystyrene				Polycarbonate ¹			
			Cat. No.	Type	Cover Color	Std. Pk.	Cat. No.	Type	Cover Color	Std. Pk.
	Enclosure - low cover	90 mm (3.54 in)	110-406	PS 1811-9-o	gray	2	120-406	PC 1811-9-o	gray	2
	Enclosure - high cover	111 mm (4.37 in)	110-906	PS 1811-11-o	gray	2	120-906	PC 1811-11-o	gray	2
	Enclosure - top hat cover	165 mm (6.50 in)	109-406	PS 1811-16-o	gray	2	121-406	PC 1811-16-o	gray	2
	Enclosure - low cover	90 mm (3.54 in)	111-006	PS 1811-9-to	trans.	2	130-006	PC 1811-9-to	trans.	2
	Enclosure - high cover	111 mm (4.37 in)	111-506	PS 1811-11-to	trans.	2	130-506	PC 1811-11-to	trans.	2
	Enclosure - top hat cover	165 mm (6.50 in)	112-006	PS 1811-16-to	trans.	2	131-006	PC 1811-16-to	trans.	2

Sidewalls with Metric Knockouts

Ordering Information		Height mm (in)	Polystyrene				Polycarbonate ¹			
			Cat. No.	Type	Cover Color	Std. Pk.	Cat. No.	Type	Cover Color	Std. Pk.
	Enclosure - low cover	90 mm (3.54 in)	105-406	PS 1811-9-m	gray	2	127-406	PC 1811-9-m	gray	2
	Enclosure - high cover	111 mm (4.37 in)	105-906	PS 1811-11-m	gray	2	127-906	PC 1811-11-m	gray	2
	Enclosure - top hat cover	165 mm (6.50 in)	104-406	PS 1811-16-m	gray	2	128-406	PC 1811-16-m	gray	2
	Enclosure - low cover	90 mm (3.54 in)	106-006	PS 1811-9-tm	trans.	2	137-006	PC 1811-9-tm	trans.	2
	Enclosure - high cover	111 mm (4.37 in)	106-506	PS 1811-11-tm	trans.	2	137-506	PC 1811-11-tm	trans.	2
	Enclosure - top hat cover	165 mm (6.50 in)	107-006	PS 1811-16-tm	trans.	2	138-006	PC 1811-16-tm	trans.	2

Accessories

Ordering Information	Cat. No.	Type	Std. Pk.
Mounting Plate	195-006	MP1811	1
DIN Rail TS35-144mm	198-144	TS 35/144	1
Hinge Kit Set	190-005	HK2	1
Mounting Tab Kit	194-001	MT1	1

Please refer to pages 116-120 for additional accessories and detailed information.

Dimensions

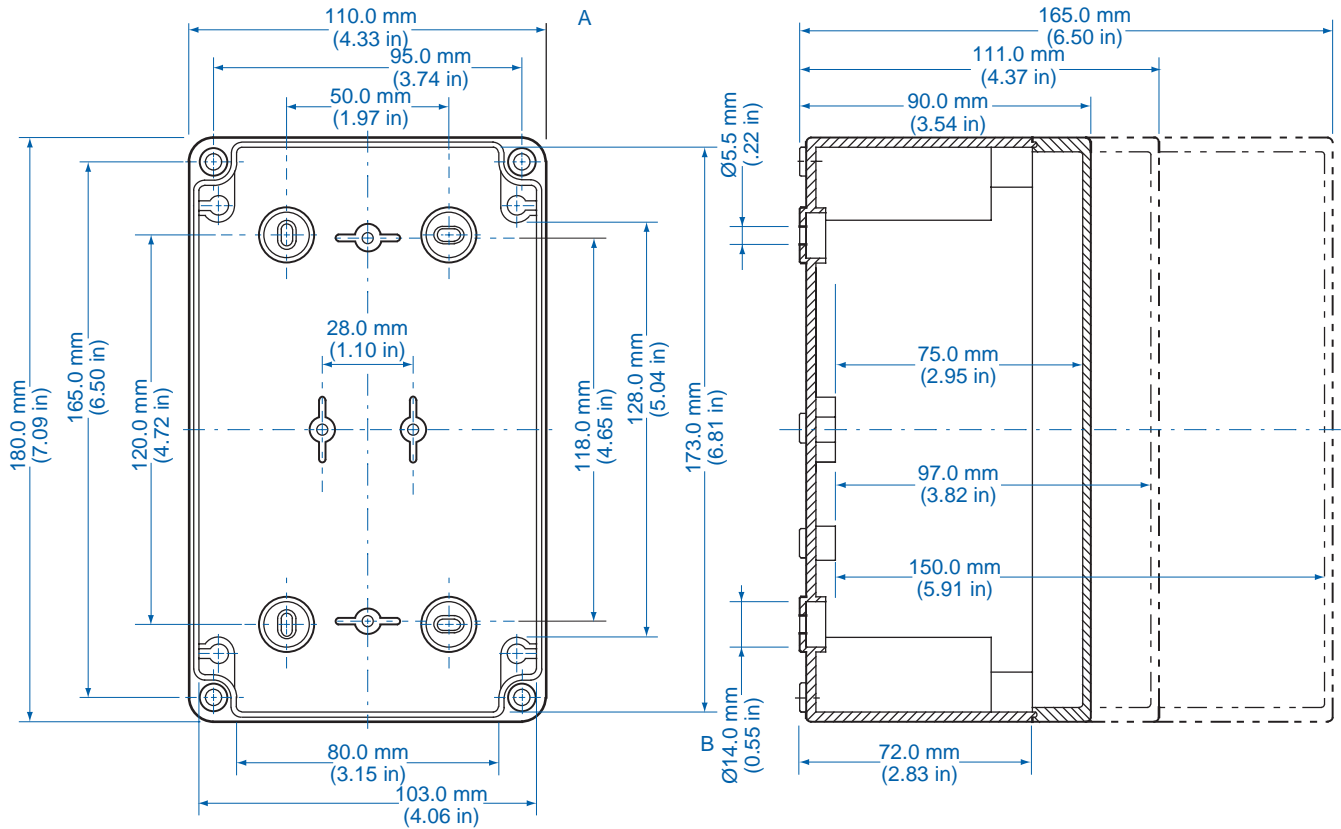

Knockout Positions

Side A

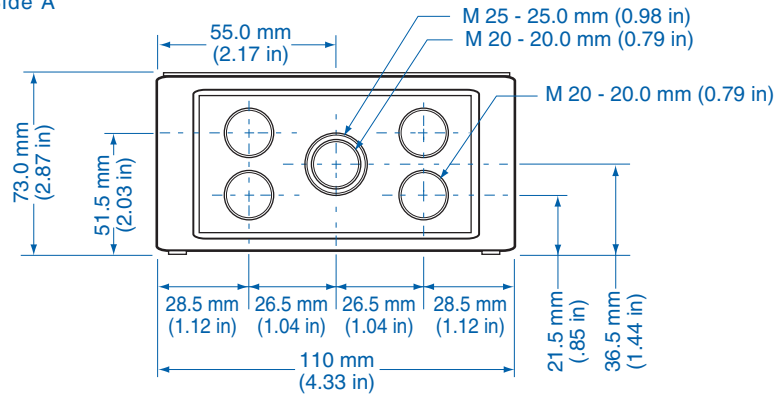

Side B

